

PARTICOLARE SEZIONE

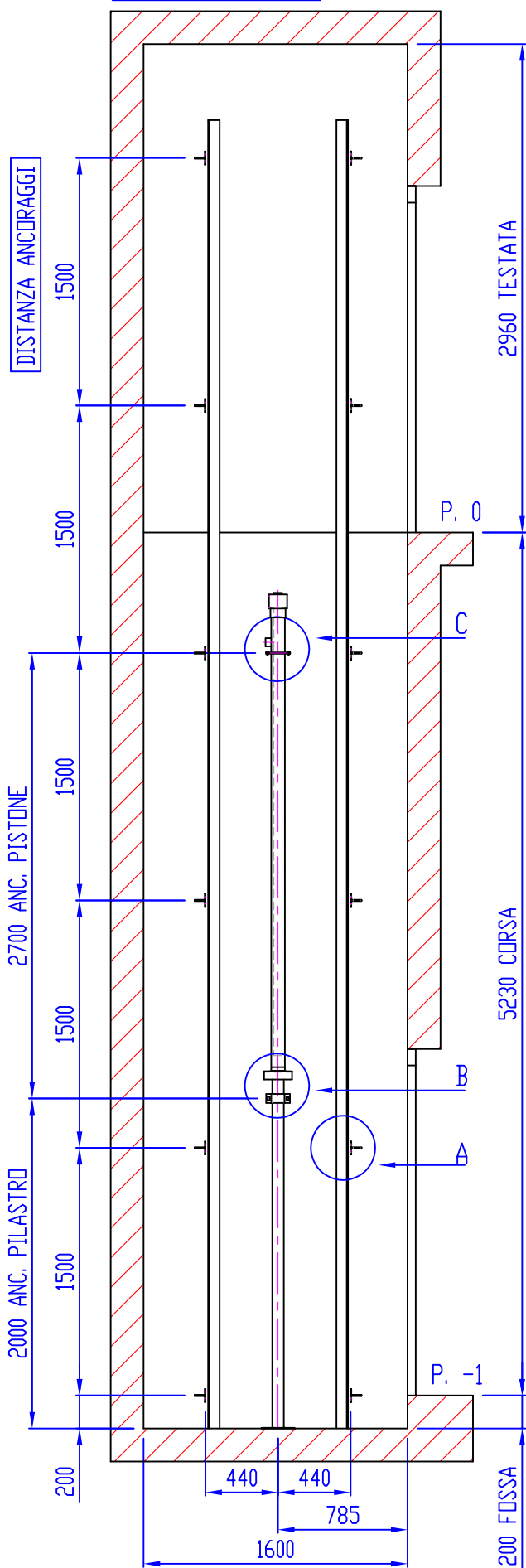

PARTICOLARE SEZIONE

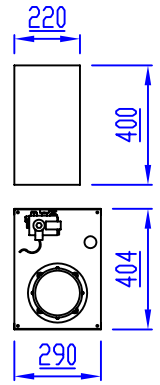
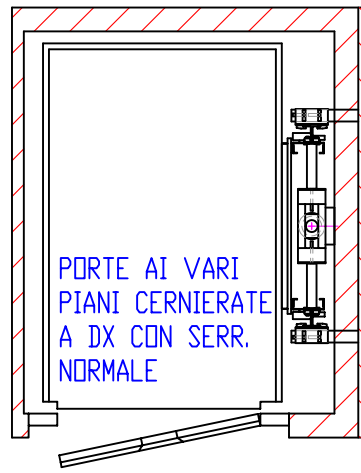

CENTRALINA AL P. -1
DISTANTE 2 m.
DAL PISTONE

RESTITUIRE FIRMATO
PER VS. BENESTARE

TIPI DI ANCORAGGIO

PARTICOLARE A:
STAFFE ANCORAG.
GUIDE

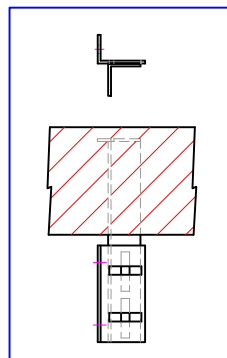

PARTICOLARE B:
STAFFE ANCORAG.
PILASTRO

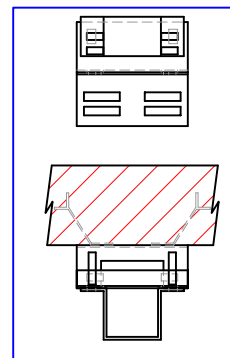

PARTICOLARE C:
STAFFE ANCORAG.
PISTONE



TABELLA DEI CARICHI

S1x=560 N

S2y=780 N

CARICO FONDO FOSSA=750 daN

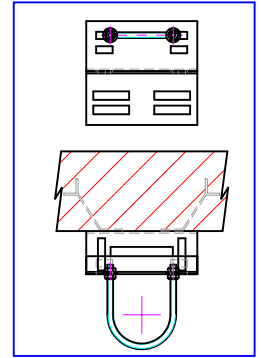
CARICO SUI MONTANTI "C"=

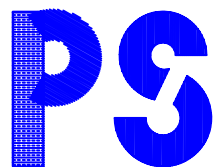
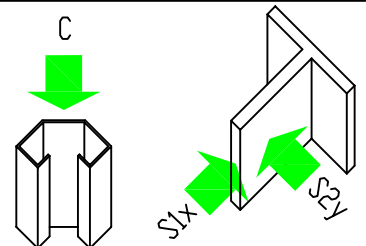

Pizzeghella Stevan

DENOMINAZIONE

VENDITORE

DATA

DISEG.

VISTA

FORM.

SCALA

MODIFICHE

N° DISEGNO

DISEGNO DI NOSTRA PROPRIETA' -- RIPRODUZIONE VIETATA AI SENSI DI LEGGE